

**1 Watt Power Amplifier  
4.9 - 6.0 GHz**

**MAAPSS0096  
V1**

**Features**

- 802.11a Applications
- WiMax Applications
- Saturated Output Power: 31.5 dBm at +7 V  
29.0 dBm at +5 V
- Gain: 20.5 dB
- No External RF Matching
- Meets 802.11a Linearity Requirements
- Lead-Free 4 mm 16-Lead PQFN Package
- 100% Matte Tin Plating over Copper
- Halogen-Free “Green” Mold Compound
- 260°C Reflow Compatible
- RoHS\* Compliant Version of MAAPSM0008

**Description**

The MAAPSS0096 is a two-stage power amplifier mounted in a lead-free, 4 mm 16-lead PQFN plastic package.

The MAAPSS0096 is designed specifically for the UNII, MMAC, WiMax, and Hiperlan bands (4.9 GHz - 6.0 GHz). It has fully matched, 50-ohm input and output ports, eliminating the need for external RF tuning components.

M/A-COM fabricates the MAAPSS0096 using a self-aligned gate MESFET process to realize high power efficiency and small size. The process features full passivation for performance and reliability.

**Ordering Information<sup>1</sup>**

Part Number	Package
MAAPSS0096TR	1000 piece reel
MAAPSS0096TR-3000	3000 piece reel
MAAPSS0096SMB	Sample Test Board

1. Reference Application Note M513 for reel size information.

**Functional Schematic**

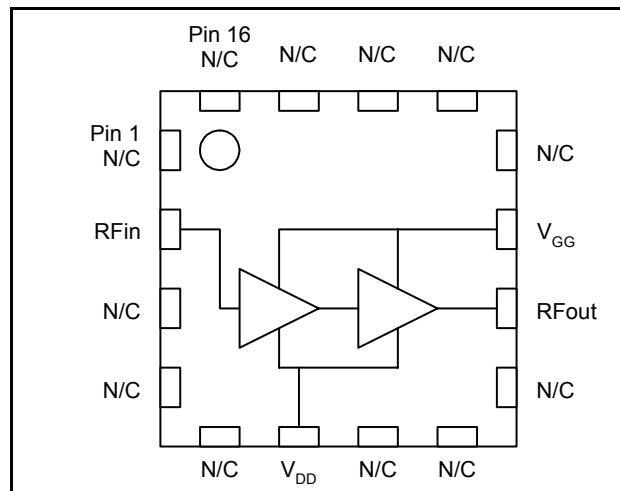

**Pin Configuration**

Pin No.	Function	Description
1	N/C	No connection
2	RFin	RF input to the amplifier. DC block on-chip. 50-ohm input.
3	N/C	No connection
4	N/C	No connection
5	N/C	No connection
6	V <sub>DD</sub>	Positive voltage supply to both stages
7	N/C	No connection
8	N/C	No connection
9	N/C	No connection
10	RFout	RF output of the amplifier. DC block on-chip. 50-ohm output.
11	V <sub>GG</sub>	Negative voltage supply to the gates of both stages
12	N/C	No connection
13	N/C	No connection
14	N/C	No connection
15	N/C	No connection
16	N/C	No connection
17	Paddle <sup>2</sup>	RF and DC Ground

2. The exposed pad centered on the package bottom must be connected to RF and DC ground.

\* Restrictions on Hazardous Substances, European Union Directive 2002/95/EC.

**1 Watt Power Amplifier  
4.9 - 6.0 GHz**

**MAAPSS0096  
V1**

**Electrical Specifications:  $T_C = 40\text{ }^\circ\text{C}$ ,  $V_{DD} = 7.0\text{ V}$ ,  $V_{GG} = -1.8\text{ V}$ ,  $Z_0 = 50\text{ }\Omega$**

Parameter	Test Conditions	Units	Min.	Typ.	Max.
Input VSWR	F = 5.825 GHz, $P_{IN} = +14\text{ dBm}$	—	—	1.5:1	2.0:1
Gain	F = 5.825 GHz, $P_{IN} = 0\text{ dBm}$	dB	18.0	20.5	—
P1dB	F = 5.825 GHz	dBm	—	29.5	—
Saturated Power	F = 5.825 GHz, $P_{IN} = +14\text{ dBm}$	dBm	29.2	31.5	—
Drain Current at Psat	F = 5.825 GHz, $P_{IN} = +14\text{ dBm}$	mA	—	500	600
2nd Harmonics 3rd Harmonics	Output Power = 29.5 dBm	dBc dBc	— —	-40 -70	— —
Thermal resistance <sup>3</sup>	2 <sup>nd</sup> Stage Only	$^\circ\text{C/W}$	—	31	—
Third-Order Intercept Point		dBm	—	40	—
Stability	+3 V < $V_{DD}$ < +10 V, $P_{IN}$ < +14 dBm, VSWR < 6:1, -25 $^\circ\text{C}$ < $T_C$ < 85 $^\circ\text{C}$ , RBW = 3 MHz (max. hold)	—	All spurs < -70 dBc		
Noise Figure	F = 5.825 GHz	dB	—	5.3	—

3. When using the thermal resistance, you must use the power dissipated by the second stage only (not the total power dissipated). The second stage dissipates 80% of the total power.

**Recommended Operating Conditions<sup>4,5</sup>**

Characteristic	Symbol	Unit	Min.	Typ.	Max.
Drain Voltage	$V_{DD}$	V	4.5	7.0	8.0
Gate Voltage <sup>5</sup>	$V_{GG}$	V	-2.5	-1.8	-1.0
Input Power	$P_{IN}$	dBm		—	15
Gate Current	$I_{GG}$	mA	-4	1	+4
Case Temperature	$T_C$	$^\circ\text{C}$	-40	25	85

4. Operation outside of these ranges may reduce product reliability.  
5. A 100-ohm resistor should be used in the gate voltage line.

**Absolute Maximum Ratings<sup>6,7</sup>**

Parameter	Absolute Maximum
Input Power (4.9 - 6.0 GHz)	+ 15 dBm
Operating Voltages	+10 volts
Operating Temperature	-40 $^\circ\text{C}$ to +70 $^\circ\text{C}$
Channel Temperature	+150 $^\circ\text{C}$
Storage Temperature	-40 $^\circ\text{C}$ to +150 $^\circ\text{C}$

6. Exceeding any one or combination of these limits may cause permanent damage to this device.  
7. M/A-COM does not recommend sustained operation near these survivability limits.

**Handling Procedures**

Please observe the following precautions to avoid damage:

**Static Sensitivity**

Gallium Arsenide Integrated Circuits are sensitive to electrostatic discharge (ESD) and can be damaged by static electricity. Proper ESD control techniques should be used when handling these devices.

**Operating The MAAPSS0096**

To operate the device, follow these steps.

1. Apply  $V_{GG} = -1.8\text{ V}$ ,  $V_{DD} = 0\text{ V}$ .
2. Ramp  $V_{DD}$  to desired voltage, typically 5 to 7 V.
3. Adjust  $V_{GG}$  to set  $I_{DQ}$ , (approximately -1.8 V).
4. Set RF input.
5. Power down in reverse sequence . Turn gate voltage off last.

**Application Information**

**Sample Board**

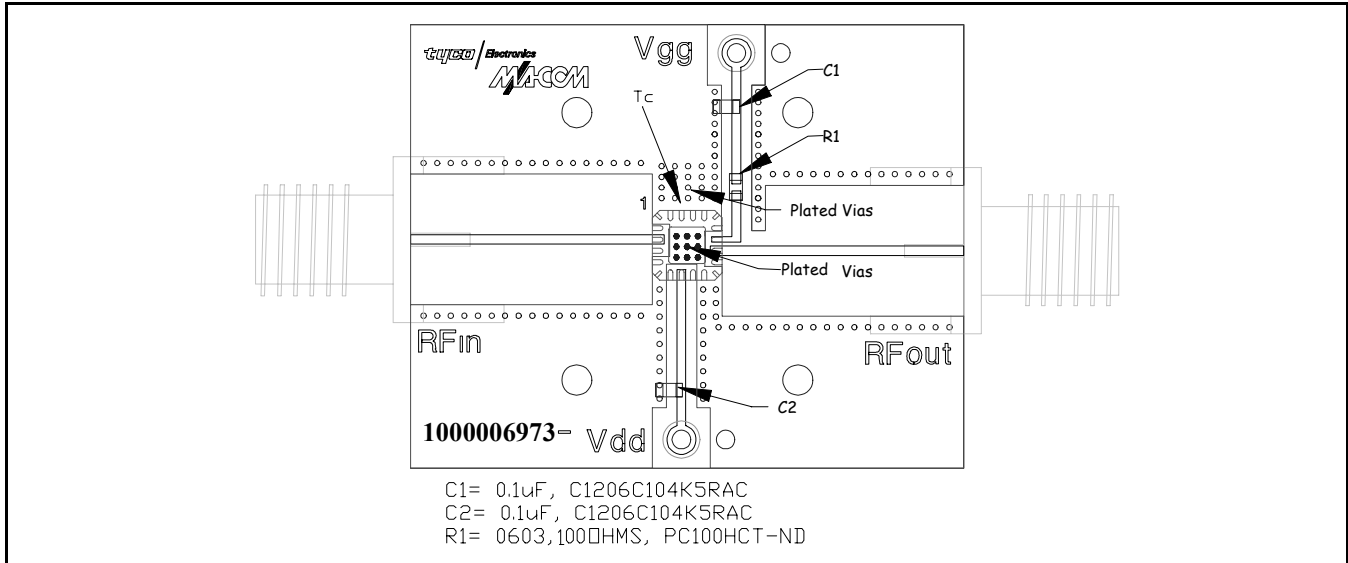

**Notes on board design**

1. Sample board uses RO4350 ( $\epsilon_r = 3.48$ ) as dielectric for circuit board. Dielectric thickness is not critical but RFin and RFout transmission lines should be 50 ohms ( $w = 22$  mil for thickness = 10 mil).
2. Solder the exposed paddle on the back of the package to the board. Proper attachment of the exposed paddle is essential for RF and DC ground in addition to providing a low thermal resistance.
3. Case temperature ( $T_c$ ) is measured on the top circuit board metal as close to the body of the package as possible (see sample board drawing).
4. The board must provide adequate heat sinking to accommodate the 2.5 W typically dissipated under small signal conditions. Sample board uses vias in the vicinity of the ground pad to provide a suitable heat sink connected to the ground plane of the board as shown above.
5. Placement of C1, C2 and R1 are not critical but use of size 1206 for the bypass caps (C1 and C2) is critical.

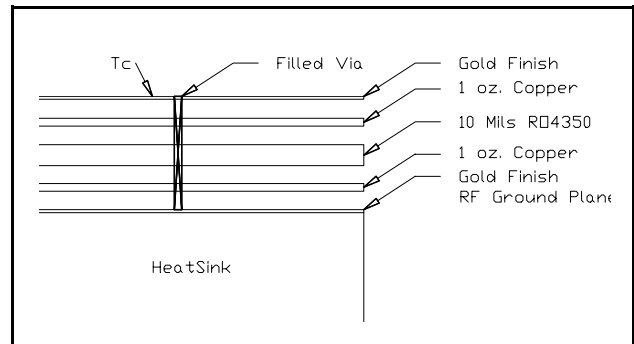

**1 Watt Power Amplifier  
4.9 - 6.0 GHz**

**MAAPSS0096  
V1**

**Typical Performance Curves**

**Gain,  $P_{IN} = +6 \text{ dBm}$ ,  $V_{DD} = 7 \text{ V}$**

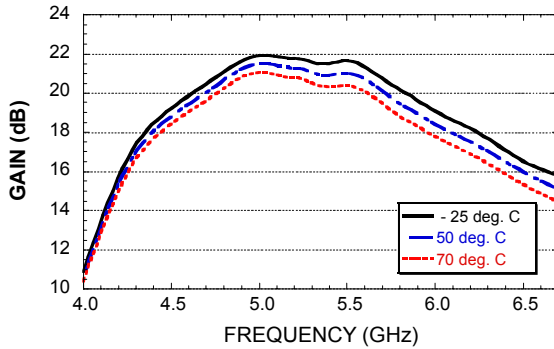

**Gain,  $P_{IN} = +6 \text{ dBm}$ ,  $V_{DD} = 5 \text{ V}$**

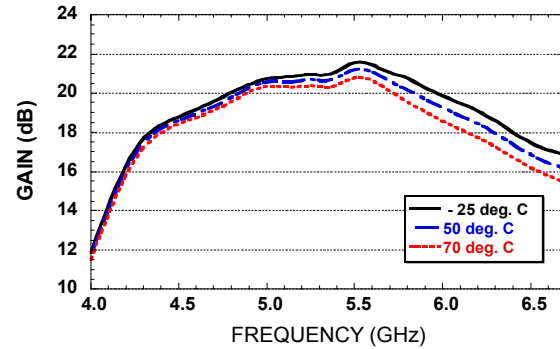

**Output Power,  $P_{IN} = +12 \text{ dBm}$ ,  $V_{DD} = 7 \text{ V}$**

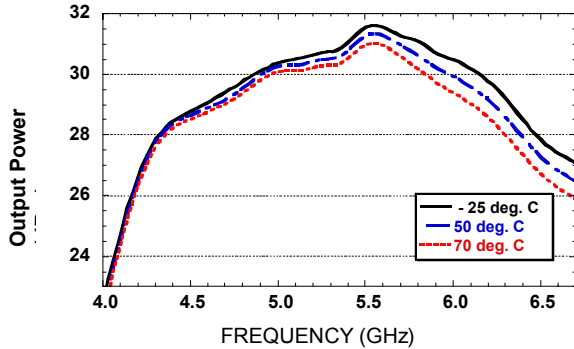

**Output Power,  $P_{IN} = +12 \text{ dBm}$ ,  $V_{DD} = 5 \text{ V}$**

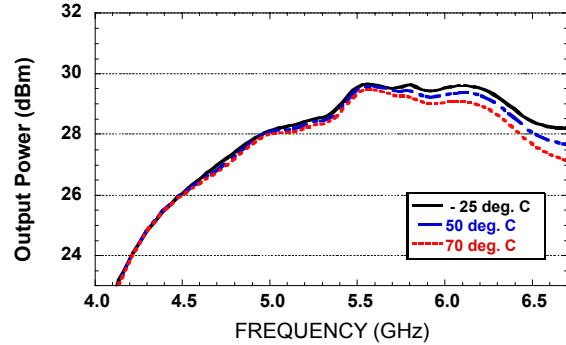

**PAE,  $P_{IN} = +12 \text{ dBm}$ ,  $V_{DD} = 7 \text{ V}$**

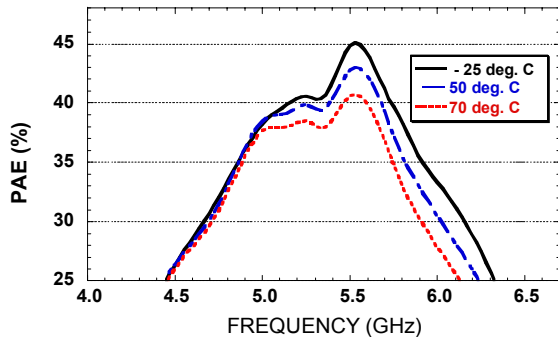

**PAE,  $P_{IN} = +12 \text{ dBm}$ ,  $V_{DD} = 5 \text{ V}$**

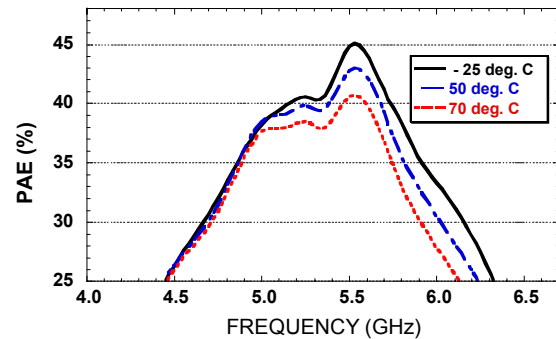

**1 Watt Power Amplifier  
4.9 - 6.0 GHz**

**MAAPSS0096  
V1**

**Typical Performance Curves**

*Input Return Loss,  $P_{IN} = +12$  dBm,  $V_{DD} = 7$  V*

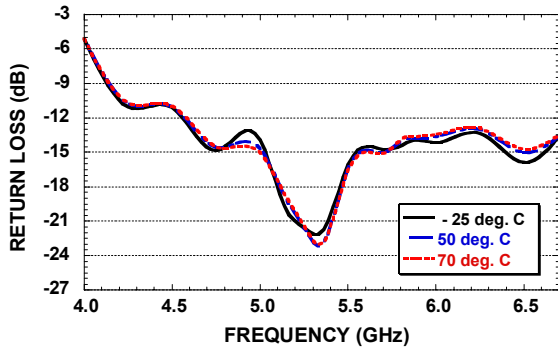

*Input Return Loss,  $P_{IN} = +12$  dBm,  $V_{DD} = 5$  V*

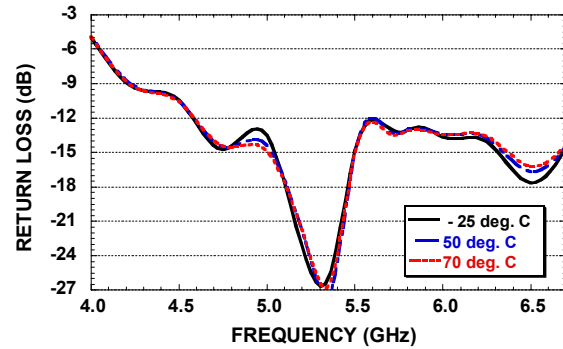

*Stage 2 Dissipated Power vs. Case Temperature  
Freq = 5.25 GHz,  $V_{DD} = 7$  V*

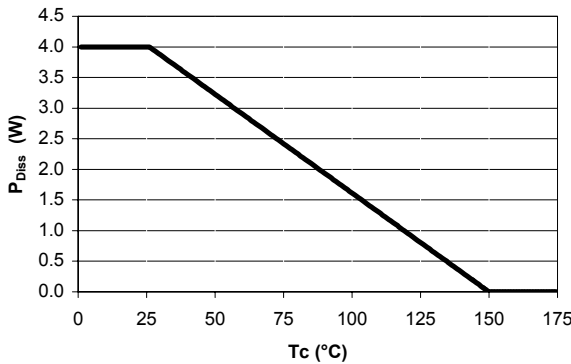

*Output Power & Gain vs. Input Power  
Freq = 5.80 GHz,  $V_{DD} = 7$  V*

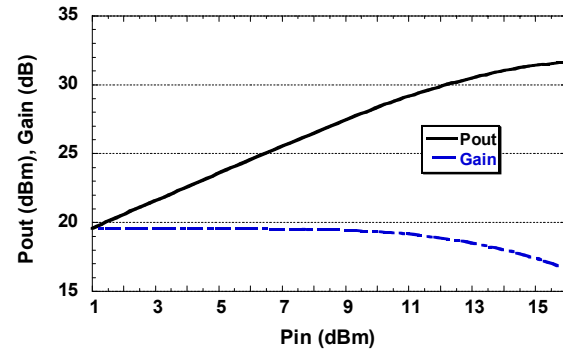

*1-dB Compression,  $V_{DD} = 7$  V,  $I_{DQ} = 0.360$  A*

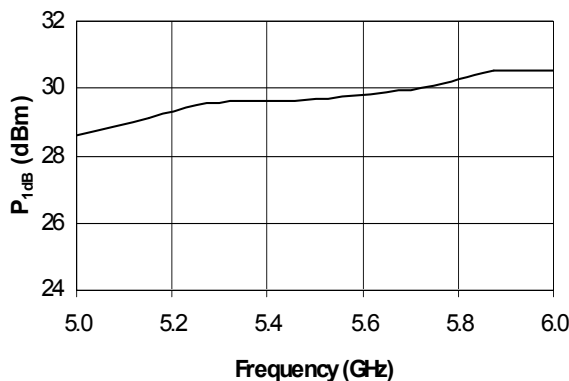

*P1dB, Gain vs. Quiescent Bias,  $V_{DD} = 7$  V,  
Freq = 5.8 GHz*

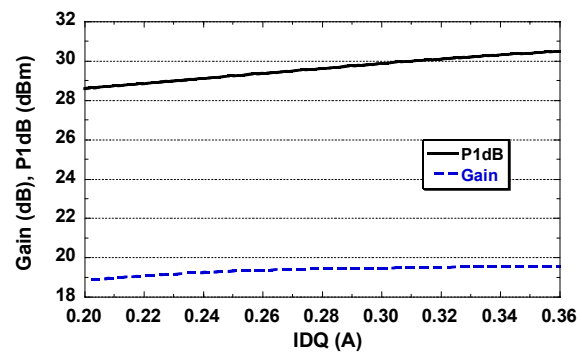

**1 Watt Power Amplifier  
4.9 - 6.0 GHz**

**MAAPSS0096  
V1**

**Typical Performance Curves**

**Noise Figure**

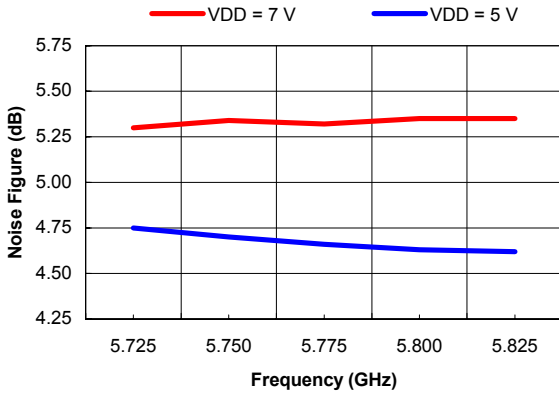

**Lead-Free 4 mm 16-Lead PQFN†**

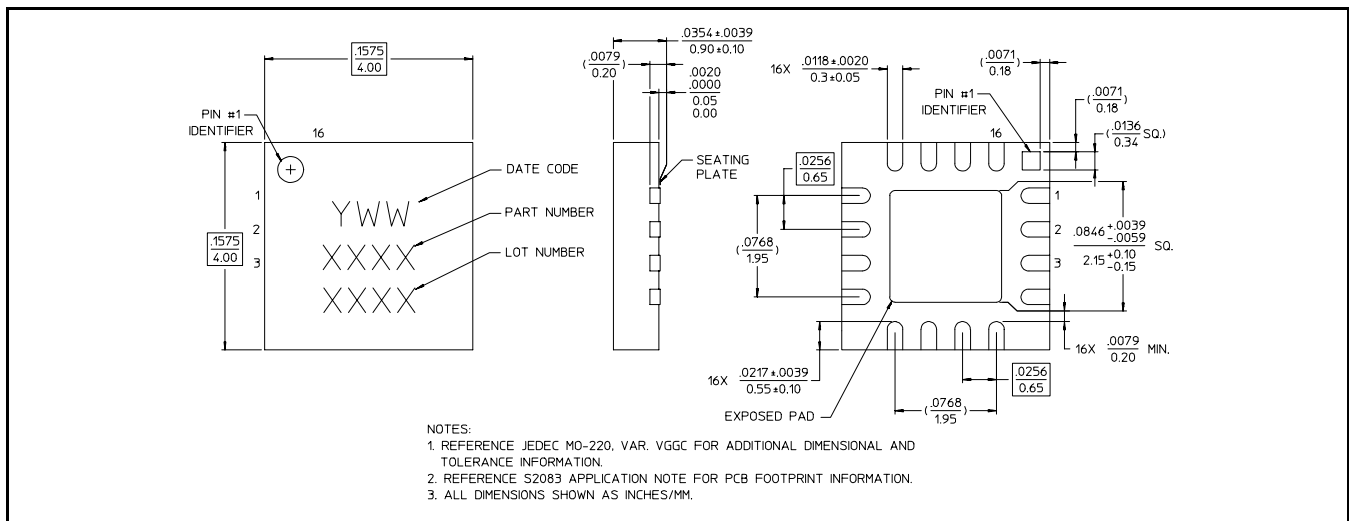

† Reference Application Note M538 for lead-free solder reflow recommendations.