

Initial Signal – Wrong no Differential

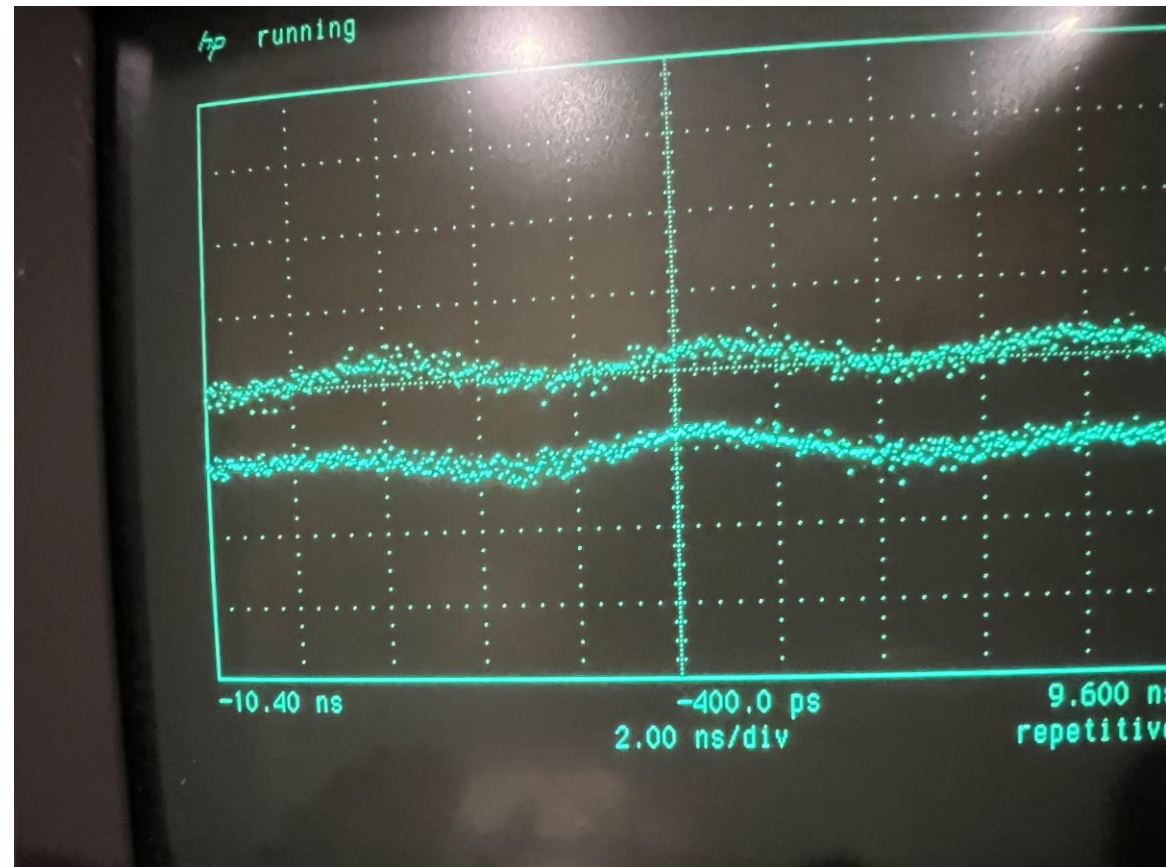

Signal after changes

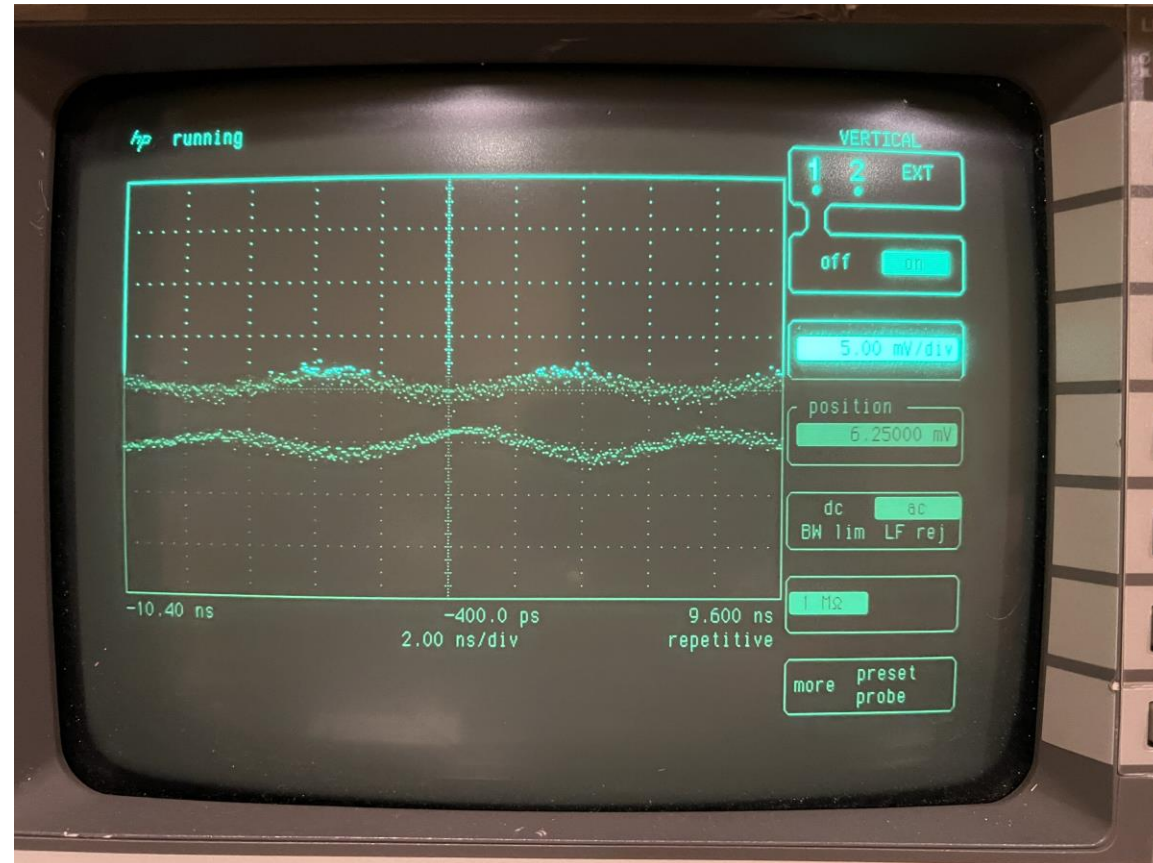

Spectrum signal level before and after change

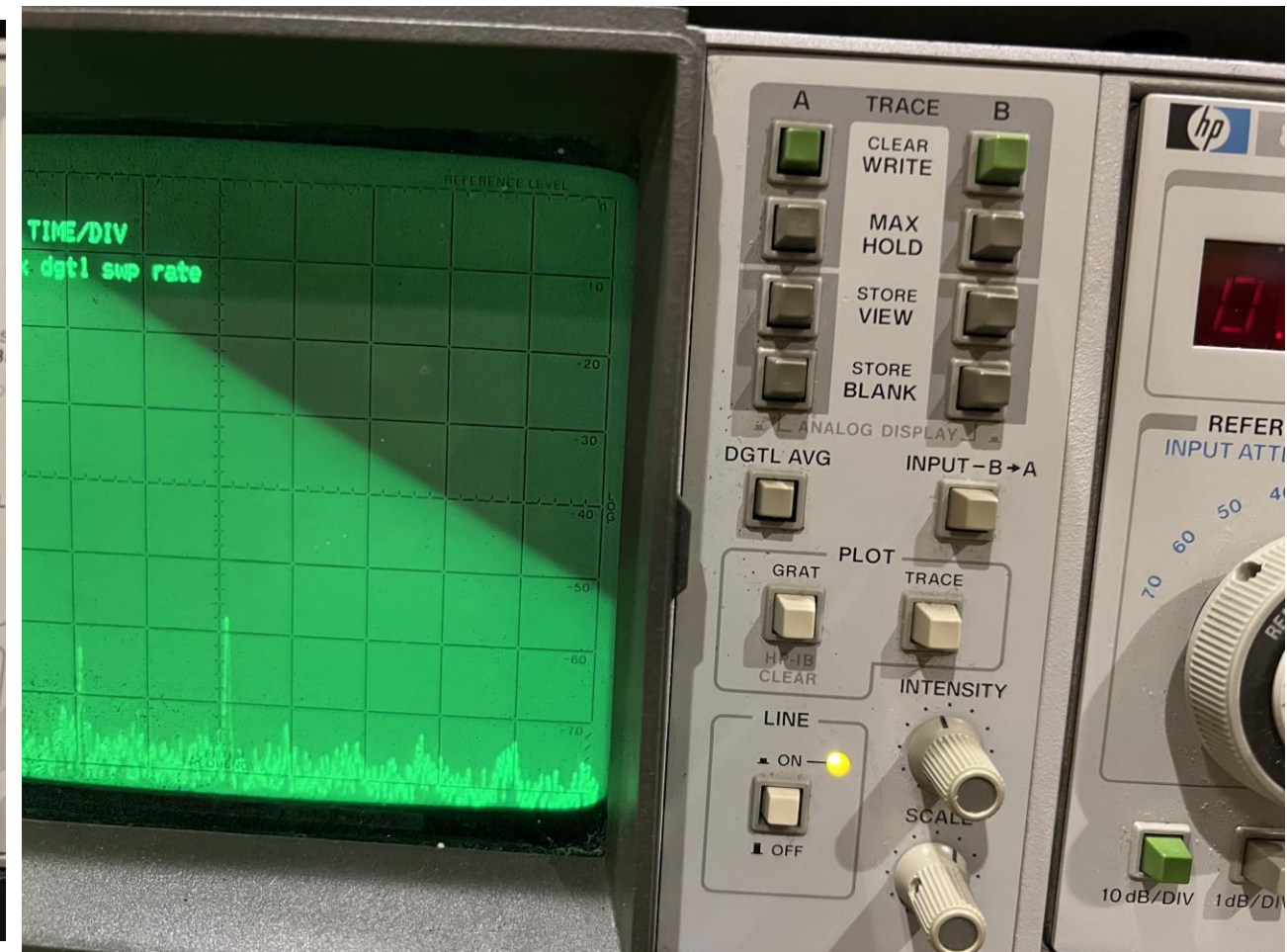
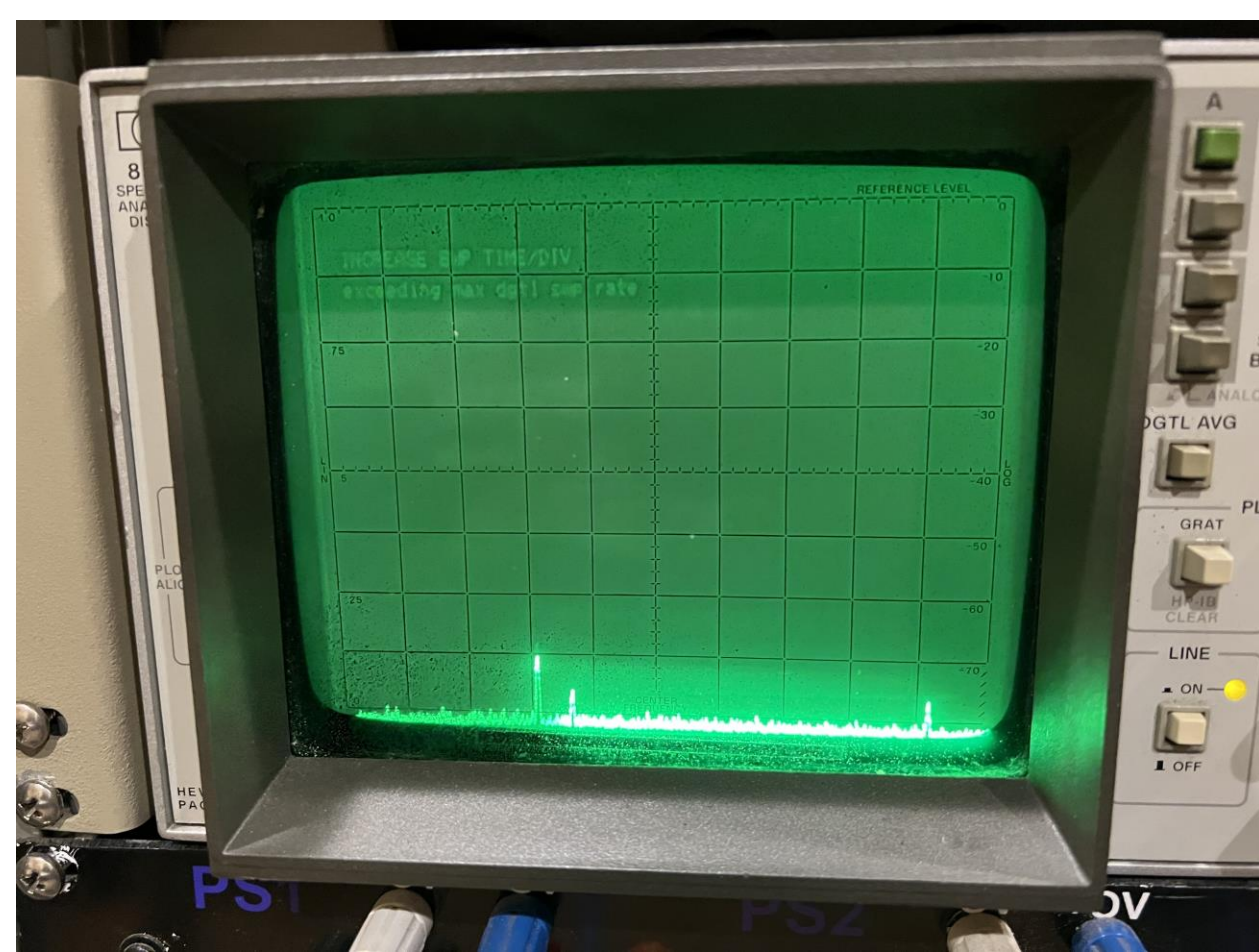

Signal at one of Rx on Differential input – too low but now differential

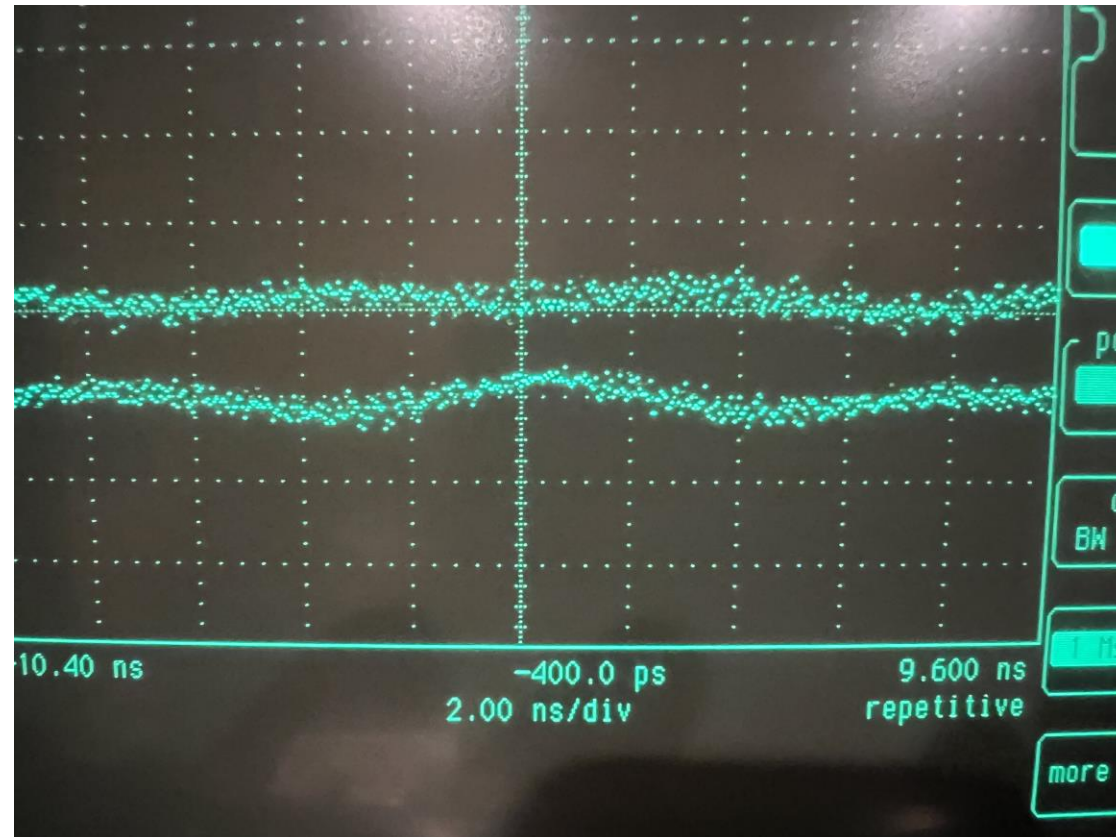

Modifications

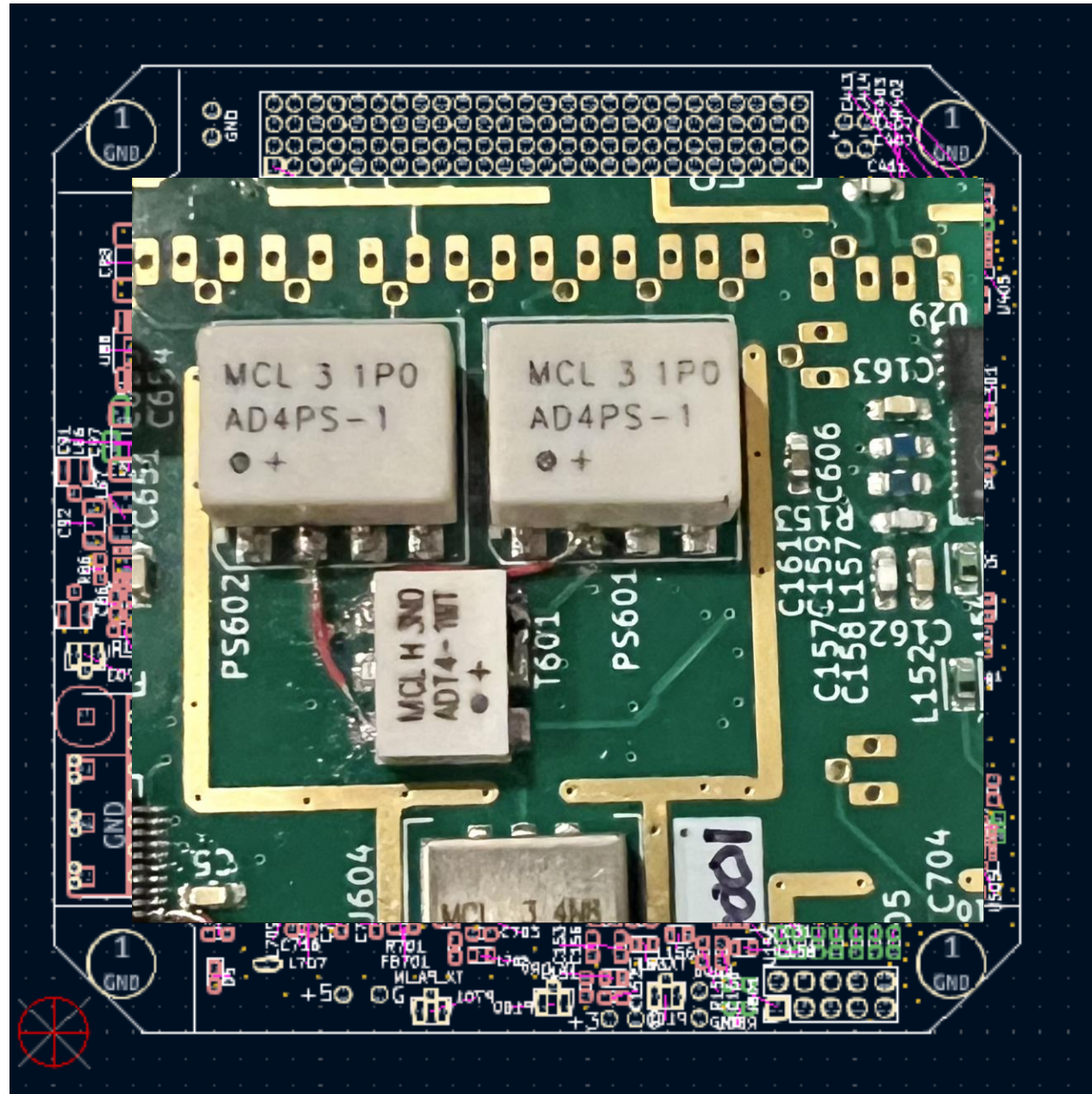

Launcpad Rx

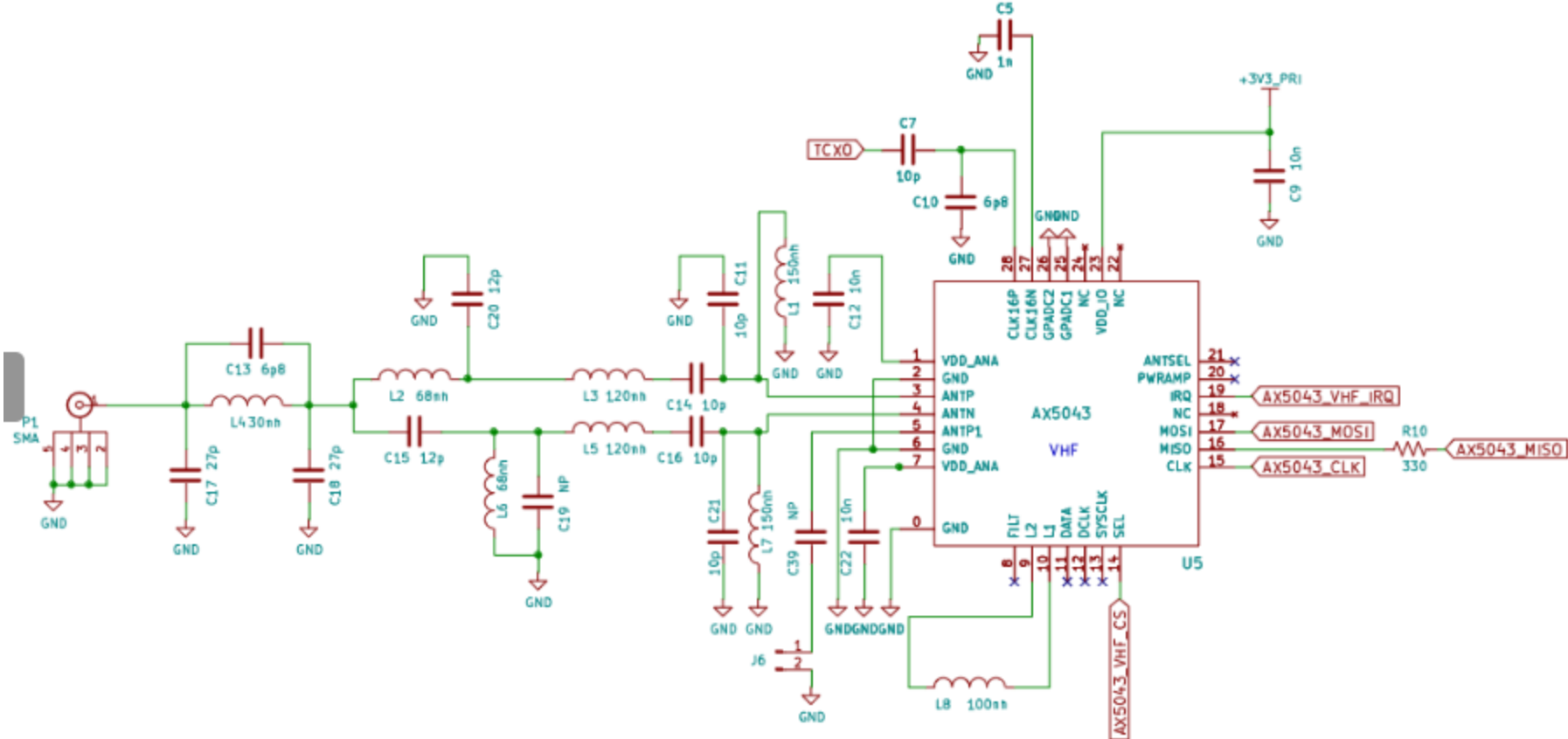

Nano VNA look at test trace for Impedance
This is imaginary portion of trace – 50 ohms

